

THE WOODWORKERS CLUB OF HOUSTON

VOLUME 19, NUMBER 5

MAY 2003

WWW.WWCH.ORG

PREZ SEZ 1:

BY KEN KOOSER

Our April meeting was very interesting we were shown some great woods and treated to some interesting and informative thoughts about woodworking. Since we don't report (have never in my six years) what goes on at the board meetings let me tell you; we keep minutes of our meetings, so we approve the minutes of our last meeting. Then the treasurer gives a report. We ended last year on a positive note and have maintained a tight reign on our spending. We work on old business, new business and then each board member has a chance to throw out anything they like. We attempt to follow Roberts's rules of order, but are very informal. Everyone attending the meeting gets a chance to speak. Last time we approved the process of getting a sample hat for the club to order. We discussed shirts. Asked John Gay to submit a plan and cost for reworking the book library. We stuffed envelopes with flyers and newsletters to mail to former advertisers in the newsletter. We discussed calling former members to ask for their dues. We recognized Paul Koury for the excellent programs this year. That's what happened. See you in May. **LATE NEWS:** Long time member, Jim Turner passed away last Friday. Jim was very helpful to me, at the traders village woodcarvers event last fall Jim and I spent the whole day manning the club table. Jim and board member Al Morrow were building a showcase shop in the Heights. Godspeed Jim.

Below: This tractor was constructed by Denis Muras. Denis used baltic birch for the tractor and walnut for the stand.

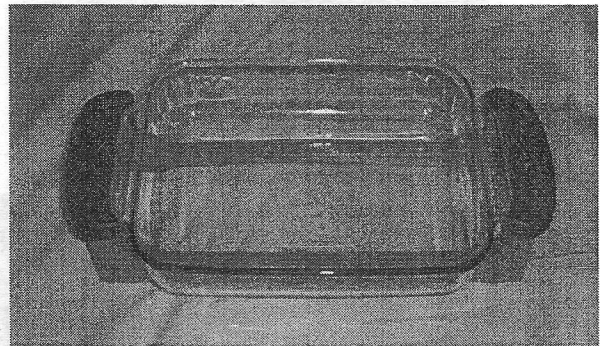
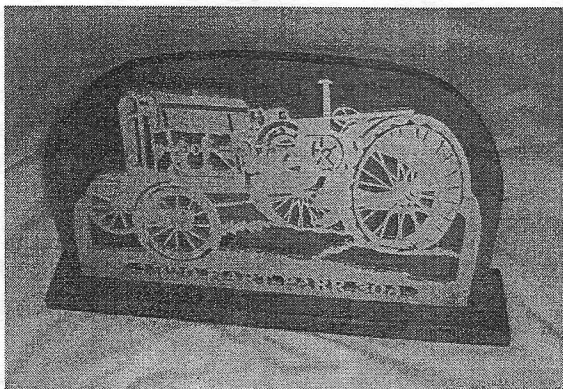

Above: Dean Hemphill made several of these cassarole dish holders. They are made from maple and cherry, and the design in the handle was done on a scrollsaw.

APRIL PROGRAM ---

SHAZ

Right: As Mike & Justin Kelly display his fine table, Shaz avoids getting trapped by ducking under it.



Above: Shaz surveys the future of woodworking in this pecan spalted bowl.

Below: A sample of some of Shaz's selection of lumber

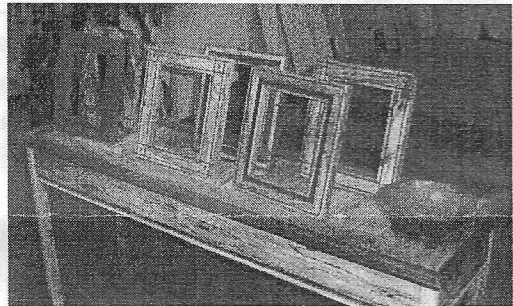

Above: These stunning picture frames were crafted by one of Shaz's co-workers. The picture really doesn't do them justice. They are fantastic!!!

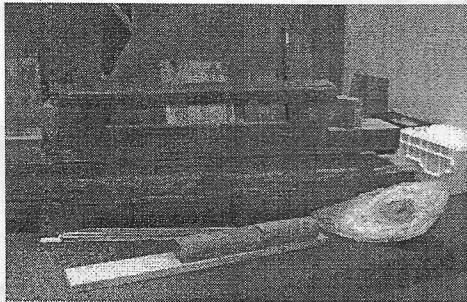

NEWSLETTER ADVERTISING RATES

The Woodworkers Club of Houston Board of Directors has set uniform rates for advertising in our newsletter. The rates agreed upon are: \$100.00-for a full page spread. \$50.00-for a half page; \$25.00 for a quarter page and \$12.50 for an 1/8 page ad. Due to the relative high cost of postage and copies the board would like the newsletter to be self supporting. This is a great opportunity for woodworking related companies to reach nearly 200 buying customers. Invoices will be sent to current advertisers asking for their support.

AT YOUR SERVICE

President:

Ken Kooser - 936-890-4099

Vice-President:

Paul Koury - 281-347-6309

Secretary:

Gary Rowen - 281-486-2013

Treasurer:

Todd Hall - 281-357-2331

Communications Director:

Justin Kelly - 281-357-0127

Director:

Art Chester - 281-379-1738

Director:

Joan Loggins - 713-729-3776

Director:

Jim Robertson - 281-263-2159

Director:

Al Morrow - 713-767-7740

Book Librarian:

Andrew Robinson - 281-286-3674

Video Librarian:

Blaine Stokes - 281-495-2920

Software & Literature Search:

Jack Hutchison - 281-493-3633

Saul Harris - 281-341-3373

Name Tags:

Joe Edelen - 281-437-5957

Coffee:

Loretta Buckley &

Bill Hochmuth

Web Master:

Gary Rowen - 281-486-2013.

row1@sbcglobal.net

Newsletter Editor:

Justin Kelly - 281-357-0127

justinkelly@swbell.net

REMINDER!!

Dues are \$24 per year.

Dues are prorated for
new members ONLY.

Renewing members in
May: \$24.

New members in
May: \$16.



Upcoming Programs

The May program will be given by either John Gay or Circle Saw. John will either be demonstrating chip carving, or Circle Saw will be hosting a question and answer session. Be sure to attend no matter who is speaking!!!

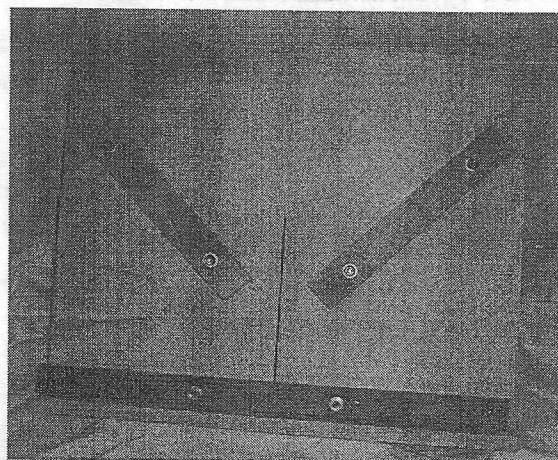

Above: Marcus Brun showed the club his table saw sled that he made from 1/2 inch baltic birch plywood.

BRANDLE'S SAWMILL

ROUGH SAWN
PINE AND
HARDWOODS

CUSTOM SAWING
AVAILABLE

LOGS UP TO 36"
DIA X 24'

13868
LAKELAND DRIVE
MONTGOMERY,
TEXAS 77356

936-597-4575

PROJECT OF THE MONTH --

SAW-TOP DUST COLLECTOR

Two of our favorite topics in the WOOD® magazine shop are dust collection and safety, and this nifty apparatus combines both. It works so well you'll never want to remove the blade guard again.

To make this handy attachment, cut a hole in the top of your existing blade guard (our guard is made of clear acrylic) and cut the hardboard adapter to fit. Seal the joint between the blade guard and the hardboard adapter with a bead of silicone sealant. Then, connect the fittings to the blade guard as illustrated below. Cut the acrylic deflector to fit. Hold the deflector in place with silicone sealant or acrylic adhesive. Dust and chips thrown forward from the saw blade bounce off the deflector and get pulled into the flexible vacuum hose. Hang the hose directly above the blade and connect it to your shop vacuum or dust-collection system.

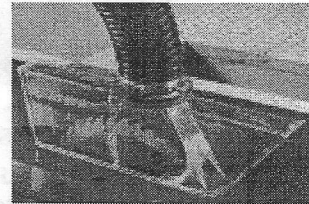

Reprinted with permission
by Wood Magazine.
www.woodmagazine.com.

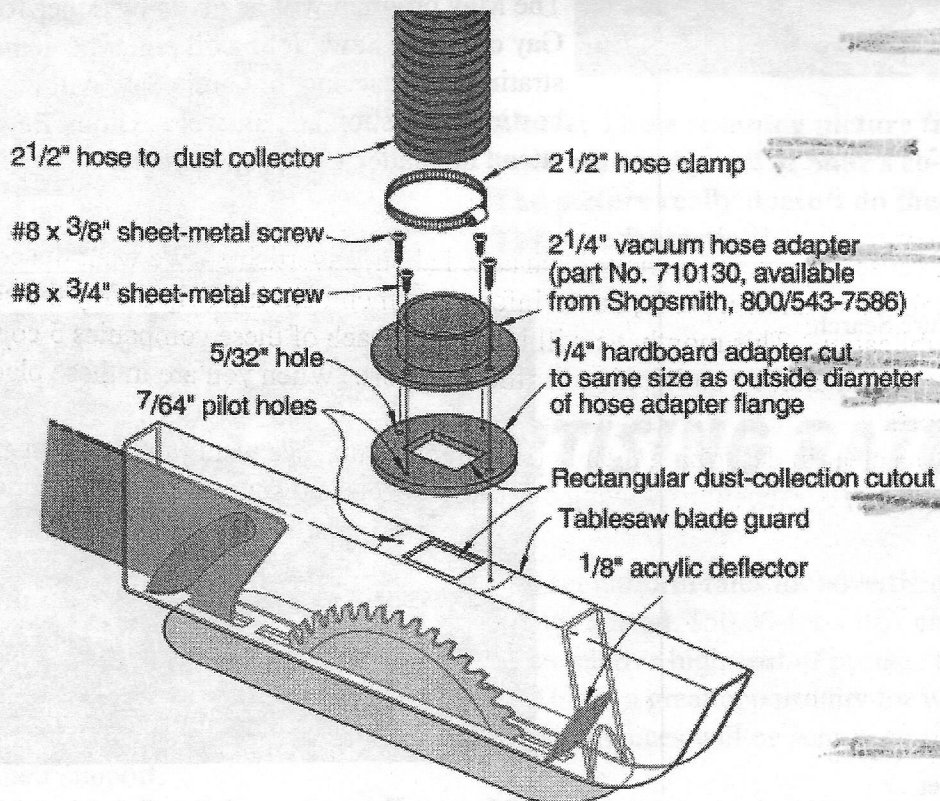

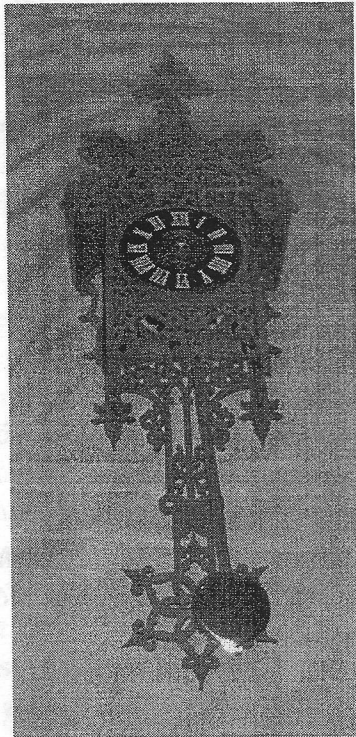

Left: This is another one of Paul Koury's fabulous scroll-sawn clocks. This one is made of an original kind of oak. Paul referred to it as "duck wood".

Below: This unusual type of box was made by our "box king", Lon Kelley. Notice the reversed wood slats. This box is somewhat unique and Lon did a great job on it!

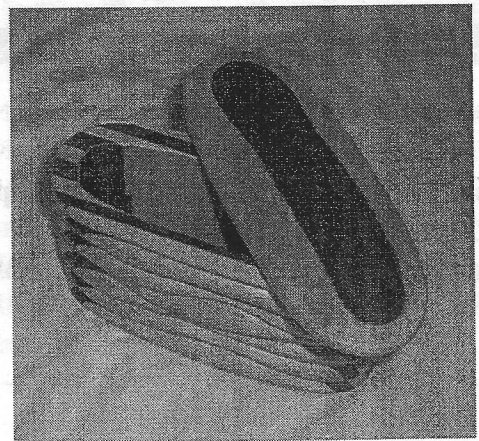

PREZ SEZ 2:

BY KEN KOOSER

March was a great meeting, program by Circle Saw Inc. – Not too many years ago they were the only shop in town handling saw blades, as well as other woodworking related items. Now the fourth largest city in America has several places we can go to for our "toys." The middle of last year I sent a letter asking many of these woodworking orientated businesses to advertise in our newsletter. None replied, yet several members have been asked about advertising. We want the companies to advertise, not for us to make a profit, but to inform our members and help defray the cost of printing our official publication. This month we will be mailing each of these companies 5 copies of our April newsletter with another solicitation for their support. When you are in these places ask them for their support.

I hope that I was clear in describing membership in our club. We want (and need) as much participation as we can get at our meetings, buying our raffle tickets and supporting "The Woodworkers Club of Houston". We will continue to provide excellent informative and entertaining programs, a forum for you to show your work, collective answers to your problems. We expect you will find value and at \$24.00 a years dues most of us think it's a bargain. We expect you to be a member to check out books and videos. We expect you to be a paid member to bring ideas to the board and to receive our official communications, this newsletter. Your officers and board members are volunteers and work for the benefit of the club. It is disheartening to see our membership drop from 209 to 119 (a loss of 50-70 members) each year at dues time. Several of us had hoped the blue dot on the badge would stir everyone to renew, yet I see several members without one. Dues will not be "pro-rated" for 2002 members paying late. Let your board know how you feel. If the \$24.00 is a problem let us know.

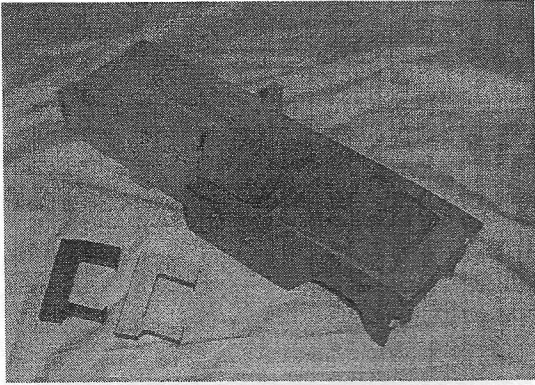

Above: Another piece of craftsmanship by Denis Muras. This one, an Apache Chevrolet pickup replica, is made from birch and mahogany.

IMPORTANT!

Immediately following the May meeting, we will be having a tool swap. Be sure to bring any tools or items you have laying around in your garage to the meeting. Attendees will be able to buy, sell, or just socialize.

Below are a list of presentors who will be giving programs and demonstrations during the coming months. Be sure to take note of the speakers and attend the meetings!

1. Bosch Tools - a mini tool fair including several give-away door prizes.
2. Titan Tool, Inc. - Our chance to learn about finishing equipment (Air Assisted, Airless, and HVLP equipment).
3. Dewalt Tools - demonstration of their tools (possibility of door prizes - stay tuned)
4. Saul Harris - long time member gives a program on table saw safety.
5. Hitachi - demonstration of thier tools (will be offering discount to WWCH members)
6. Circle Saw - return engagement for Questions & Answers
7. Delta Tools - demonstration of their tools (will also be answering questions).
8. John Gay - program on how to chip carve
9. Circle Saw - program on table saw tune up and alignment

Discover the Art of

Hand Tool Woodworking

Homestead Heritage

- Woodworking School -

Elm Mott, Texas (10 miles North of Waco)

For Brochure and Class Schedule
Call: 254-799-1480

www.homesteadheritage.com

Be sure and ask about the discount for
WWCH members!

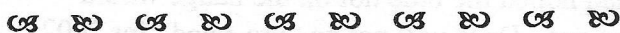

LIBRARY REPORT - MAY 2003

BY JOHN GAY

Did everyone like the woodworking show this year? I did. At the show we added two very good books to our fine collection. We bought *Shaping Wood* by *Lonnie Bird*. This book is well illustrated and almost 300 pages so if you have some designs that require some odd shapes, you need to check this book out. It's good. Also we have *Controlling Dust in the Workshop* by *Rick Peters*. Dust control is very important and we have some books on that subject but this one is very complete from a modest system to a more complex one. It covers just about everything from design to trouble shooting.

At our March meeting we had some nice donations. Bob Porter gave us some nice books on home improvement. They are *Windows & Skylights* and *Adding On*. Justin Kelly gave us several books on the scroll saw and some really good project books for the scroll saw.

I do have some sad news too. There are a lot of books that have been checked out for so long that they are just gone. This is part of the job that I don't like to do but I have tried to contact the names on the cards via Email, regular mail or phone calls but sometimes their names are not on our mailing list or their address has changed. Either way I did not get a response so we no longer have these books.

They are:

Biscuit Joiner Handbook, Jigs & Woodshop Furniture, Making Jigs & Fixtures, 250 Best Shop Tricks, Woodworkers Guide to Wood, Small Furniture, The Art of Making Elegant Wood Boxes, Joinery Basics, Understanding Wood Finishing, Setting Up Shop and Timber Frame Houses. That is a total of 11 books that are missing at a value of \$275.34 at the time when they were donated to the club. If we could replace them, it would cost more now.

So be sure to look around your place and return any books that have slipped by. Remember that the missing books not only hurts the club but also it probably upsets those who have donated these treasures to our group.

Normally I'll have a few copies of the current list if books by the cases so you can find what you are looking for quicker.

Thanks, John

Featuring the Finest Tools The World Has To Offer

English Hand Tools By Record, Stanley, Henry Taylor, & Robt. Sorby.
Japanese Saws, Chisels & Stones By Gyokucho, Matsumura, and King.
Biesemeyer, Makita, Bosch, Starrett, Irwin, Olson, Jorgensen,
Magna-Set, Freeborn, Lie-Nielsen, & Incra: All Made In The USA.
Canadian Chucks and Hand Tools By OneWay & Veritas.
European Tools by Freud, Tormek, Sjöberg, Stern, & Footprint.

PLUS: The Best Prices On JET Machinery Every Day!

We are an Authorized JET Service Center.

7123 SouthWest Fwy, Just North of Bellaire Blvd. (713) 981-9228

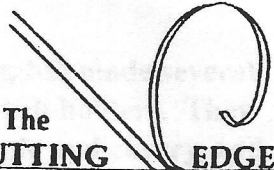

The
CUTTING **EDGE**, Inc.
A Woodworker's Tool & Supply

Mon. - Fri. 9 am to 6 pm
Sat. 10 am to 5 pm

**WOODWORKERS CLUB OF HOUSTON
30630 QUINN ROAD
TOMBALL, TEXAS 77375**

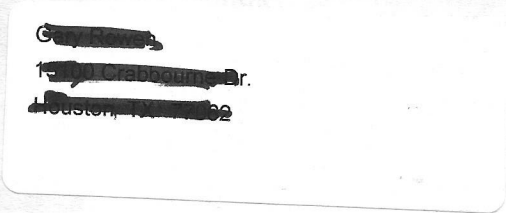
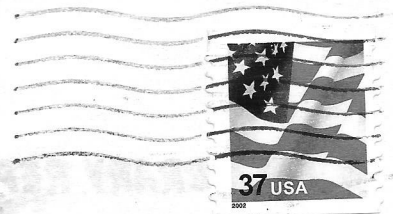

CALENDAR OF EVENTS FOR MAY:

**5/10/03 - Meeting at the Bayland
Community Center - 9:00 A.M.**

**5/10/03 - Tool Swap at the Bayland
Community Center - immediately
following general meeting.**

77062+2622

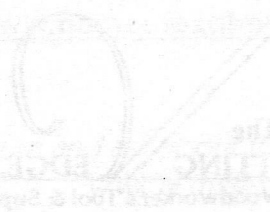
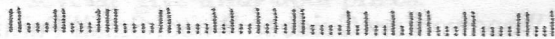

Featuring the Finest Tools The World Has To Offer

We are an Authorized JET Service Center...
Blister the Best! Only at JET...
European Japs by Japs...
Canadian Japs and Hand Tools by CanWay...
English Hand Tools by Record Stanley Taylor & Japs Japs...
Japanese Japs by Japs...
Bismeyer Japs...
Japs...
Morr - 9:00 am to 5 pm
Sat 10 am to 5 pm