

# Woodworkers Club OF HOUSTON

VOL. 5, NO. 9

SEPTEMBER, 1989

## Officers

Bill Hochmuth - President 774-1733  
Bill Sallans - Vice President 465-0291  
Bill Baker - Sec./Treasurer 667-8381  
Steve Procter - Newsletter Editor 728-1459

## Board of Directors

Sharon Buckley - 944-6739  
Zatis Murphy - 469-3563  
Don Richardson - 661-1365  
Gary Wallace - 855-3408

## AUGUST MEETING

Dr. Bill Forkner and U. of H was our host for our meeting.

The program was on Carriage Restoration by Calvin Blackwell.

## CLUB BUSINESS

**SHIRTS AND CAPS**-- If you paid for a shirt and or cap ---This will be the last time Sharon will bring them to the meeting--After that you will have to call Sharon to arrange to get your shirt and or cap.

Bill Baker will have caps for sale at \$5.00 each. If you would like to have one---Limited Quantity available at this price.

## OFFICERS FOR 1990

We are still looking for a few good Woodworkers to hold office for 1990. If your interested please contact Bill Hochmuth.

Nominations will be at the October Meeting--Election of Officers will be at the November Meeting.

## ANNUAL DINNER MEETING

Start planning if you want to attend the Dinner meeting because this year our annual dinner will be at the End of November. In next month's newsletter we will have reservation forms included.

The deadline will be October 23rd, 1989 --if you wish to attend, Bill Baker must have your reservation and Money.

The Dinner will be \$12.50 per person/\$25.00 per couple.

The evening starts with a pay bar at 7:00 P.M.--Dinner at 8:00 P.M. and Show and Tell

## Awards following Dinner.

At this time the menu has not been set--but in the past we start with a Green Salad, a nice slab of Roast Beef, potatoe, green vegetable, rolls, Desert, Coffee and or Tea.

Again it will be held at the Rice Faculty Club--Very good food and a nice large facility that we have all to ourselves.

PLEASE MAKE YOUR RESERVATION EARLY

WITH BILL BAKER

## CHARITY SHOW

The Charity Show is right around the corner Friday October 20th and Saturday October 21st at the North Court in the Greenspoint Mall, between Foley's and J. G. Penney.

We need lots and lots of items for sale. there's still time to make something for the Charity Show.

## BUY AND SELL

For Sale: 6 1/8th High Speed Jointer with iHP. 3450 motor. 36" Long Cast iron Table with stand--32" Long adjustable fence. Excellent Condition---\$250.00 Contact Bob Soderbiom--466-1223.

## CLUB ROSTER

Correction: Last month we corrected Gayle Robinsons phone number incorrectly---the new corrected number is 391-1532.



New Member please add to your Roster:  
 Wilburn Schumann Home Phone 356-5870  
 22603 Desert Willow  
 Magnolia, Tx. 77355 Work Phone 449-2211

**SEPTEMBER MEETING**

WHEN: SEPTEMBER 9TH 9:00 A. M.  
 WHERE: AUSTIN HARDWOODS  
 13001 VETERAN'S MEMORIAL DR.  
 440-0764

The September meeting will be at 9:00 A.M. in the warehouse of Austin Hardwoods. The address is 13001 Veteran's Memorial Dr. That's about a half block south of the Bammel intersection.---For a map refer to Austin Hardwoods advertisement.

**INSTRUCTORS**

For the past few months, Andy Anderson and Leo Oringderff have been working as volunteers at Pyramid House. Each week they conduct classes for clients of this branch of MIMR. The program has been well received. In fact there are enough requests to join the group, that a second weekly session is in the offing. Leo Oringderff needs to find a replacement for Andy Anderson and two additional helpers to staff a second session. Anyone interested in volunteering for two hours a week is asked to contact Leo at 445-5460.

**TWO HANDY JIGS FOR DOWELS**

**1). ADJUSTABLE V-BLOCK JIG SPACES HOLES ACCURATELY**

Accurately drilling holes in a round shape can be bothersome chore unless you work with a v-block setup. This handy jig not only provides the v-block, but also is an adjustable gauge so you can drill any number of equally spaced holes.

**2). STEP JIG FOR SAW ACCURATELY SIZES DOWELS**

Whether you use dowels for joint reinforcement or as components for projects, such as axes for toys, this step jig will allow you to cut any number to exact length.

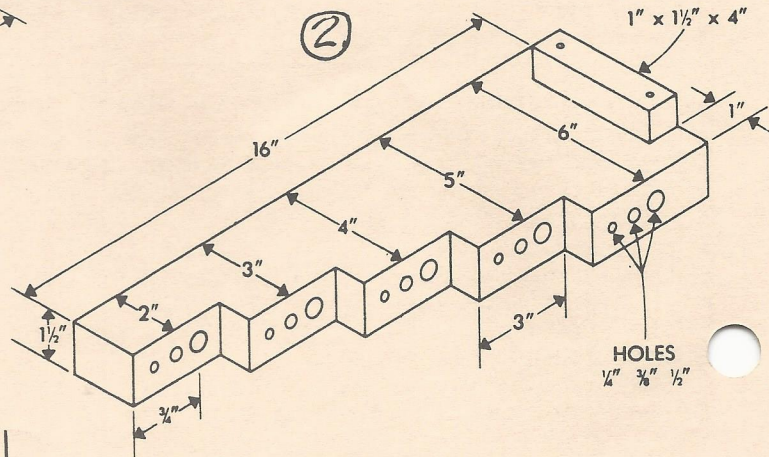
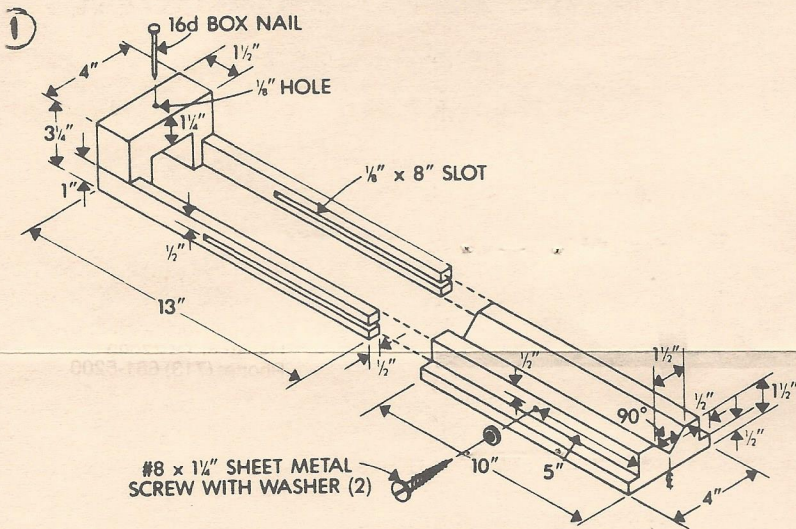



# Pasadena Industrial Supply

## Bosch Orbital Action Jigsaw

Power Tool & Accessory  
 Headquarters for;  
 Delta Machinery, Porter-Cable  
 Milwaukee, Hitachi, Bosch,  
 Ryobi, Makita, Skil.  
 Saftey-Speedcut & More!

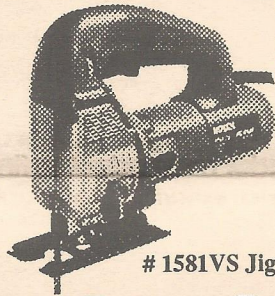

**\$ 129**

*Price good for members only!*

# 1581VS Jig saw variable speed & orbit

This is the top of the line. They just don't come better than this. This saw has a full 4.8 amp motor that can be varied with the seperate speed control in handle. Orbiting blade motion can be adjusted 4 ways to fit the job at hand. Line blower can be turned off for metal cutting. 1" cutting stroke. Uses the famous Bosch style jig saw blades

222 West Pasad-ena Freeway, Pasadena Texas 77536 472-5588

Come in and checkout our over arm router system.

Check out our hard woods - Bowl and spindle stock - Exotic hardwoods - Best prices intown.

### Hours:

Mon, Tues, Wed, & Fri:

9:00a.m. to 6:00p.m.:

Thurs: 9:00a.m. to 9:00p.m.

Sat: 9:00a.m. to 5:00p.m.

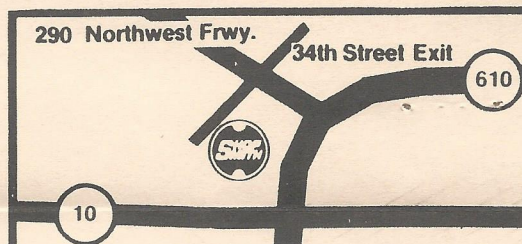

**Shopsmith Inc.**

Northway Shopping Center  
 10965A Northwest Frwy.  
 Houston, TX 77092  
 Phone: (713) 681-5200

Exp. 1-90

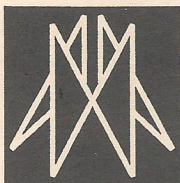

# AUSTIN HARDWOODS

13001 VETERANS MEMORIAL DR.

HOUSTON, TEXAS 77014

**440-0764**

We stock over 80 species of lumber including rare exotics and turning stock. Plywood, Veneer, Moulding, Flooring, Tools, Millwork, Paneling Etc. also available

Exp. 8/89

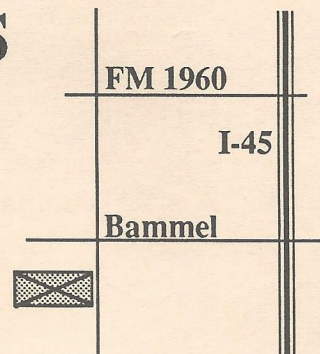



New Hampshire  
June 21, 1988



Woodworkers Club of Houston  
P.O. Box 34481  
Houston, TX 77234

## Houston Wood and Tool, Inc.



DAP Weldwood®  
Hobby & Craft Glue



DAP Weldwood®  
Plastic Resin Glue

Visit our showroom. Open Monday to Saturday

Mon., Tues, Wed & Fri 8 to 5, Thurs 8 to 8, Sat. 9 to 4.

Come by or call 680-1744 - City Sales.

Located two blocks west of Highway 290 on 34th Street.  
5857 W. 34th Street - Houston, Texas 77092

- Classes
- Fine Hand Tools
- Power Tools
- Portable Electric Tools

Exp. 4/90

## HARDWOOD LUMBER CO.

700 E. 51/2 St. (In The Heights)  
Houston, Texas 77007  
(713) 862-6628  
Hours: M-F 7:30-5:00, Sat. 8:30-1:30

We stock over 65 species of lumber including  
hard to find exotics!

**Also:** Plywood, Veneer, Moulding, Formica,  
Custom Milling, Woodworking Tools, Books, etc.

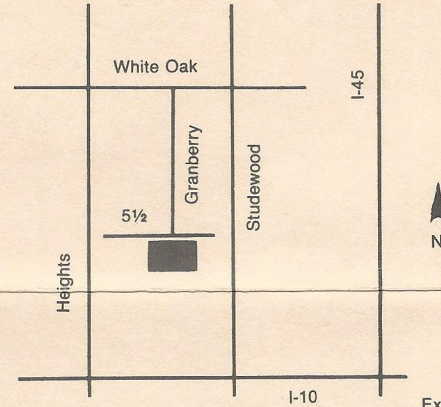

Exp. 9-89

## Send Today for the Most Complete Catalog Selection of Woodworking Supplies

Please Enclose \$1.00 (3rd class) or \$2.00 (1st class)

Name \_\_\_\_\_

Address \_\_\_\_\_

City \_\_\_\_\_ State \_\_\_\_\_ Zip \_\_\_\_\_

Orders Shipped Within 48 Hours

Exp. 5/89

21801 Industrial Blvd., Rogers, MN 55374

